



Normal Square/Rectangle Ceiling







DESCRIPTION

TOPTIDE/Ceillex normal metal ceilings include square, rectangle, strip and open cell ceilings. With mature craft and precise structure, each type of ceilings can be largely installed or different types can be assembled together. The designs are flexible, which looks simple and grandiose.



China A1



NRC up to 0.95



800×800 PERFORATED CEILING

SUSPENSION SYSTEM

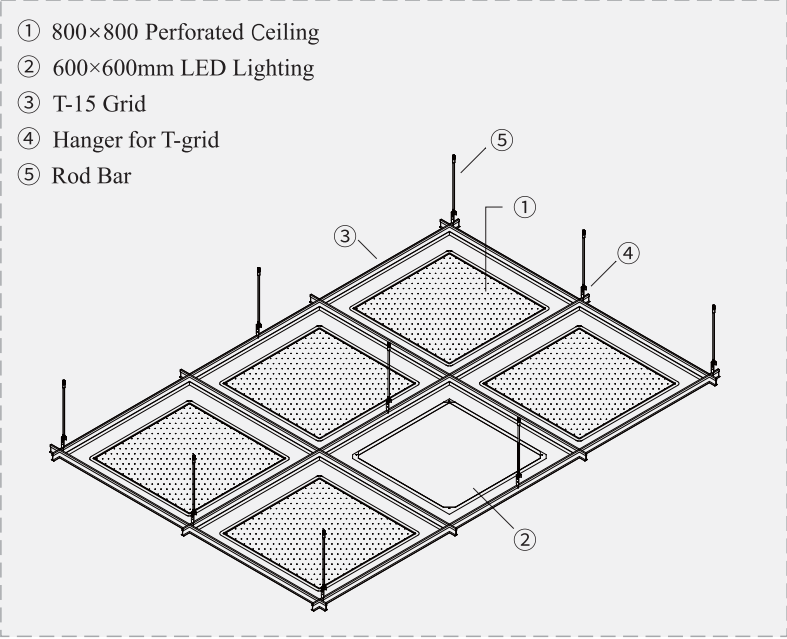

DETAILED DRAWINGS

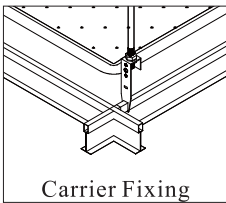

CONSTRUCTION DETAILS

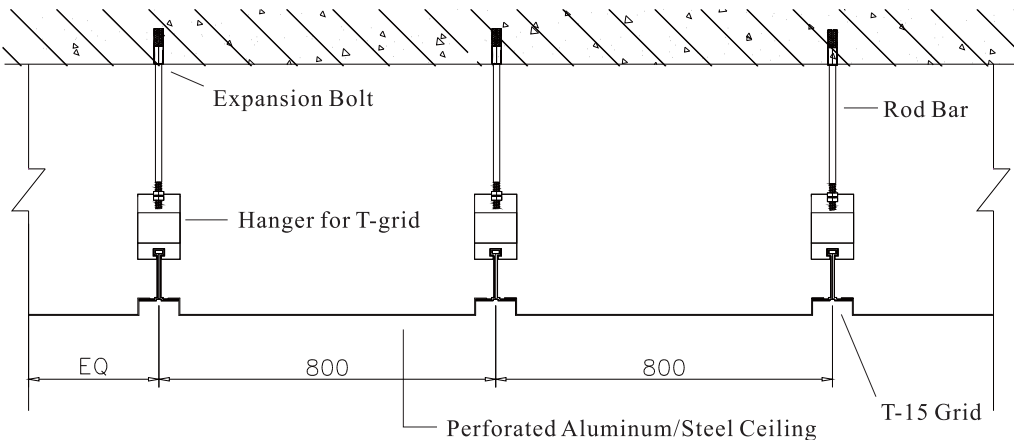

LAY IN CEILING

SUSPENSION SYSTEM



- ① Lay-in Ceiling
- ② H38 Main Runner
- ③ Hanger for Main Runner
- ④ Main Tee
- ⑤ Cross Tee
- ⑥ Hanger for Tee Grid
- ⑦ Rod Bar

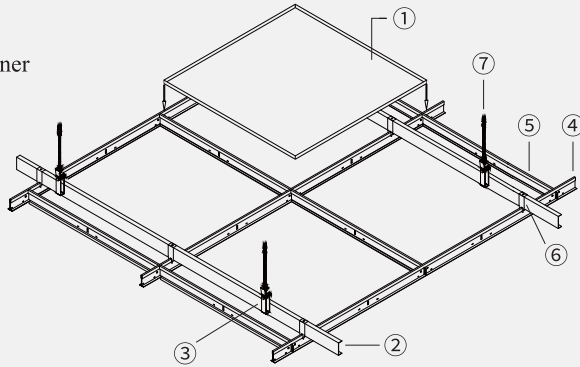

DETAILED DRAWINGS

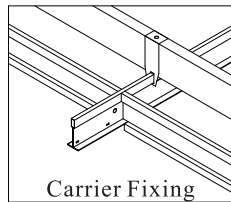
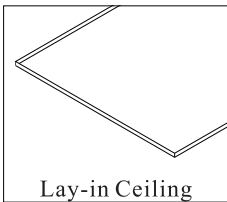

CONSTRUCTION DETAILS

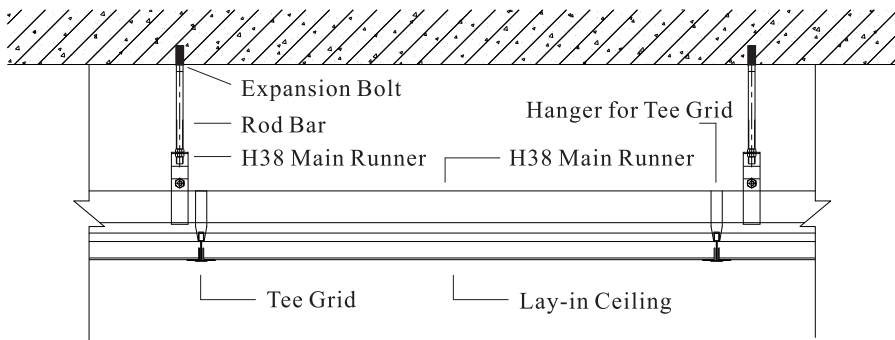

PRODUCT DATA

Material: Aluminum Alloy, Galvanized Steel

Standard Sizes: 300×300mm 600×600mm 800×800mm

300×1200mm 400×1200mm 600×1200mm

Surface Treatment: Powder Coating, PE/PVDF Finish, Anodizing, Heat Transfer Printing.

Normal Perforations:

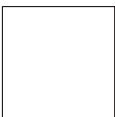

Plain

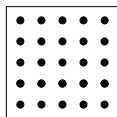

φ1.0mm Straight

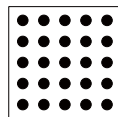

φ1.5mm Straight

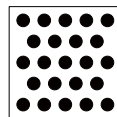

φ1.8mm Diagonal

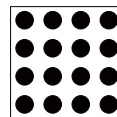

φ2.5mm Straight

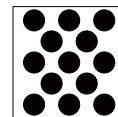

φ3.0mm Diagonal

CEILING LAYOUT



Ceiling Size 300×300mm

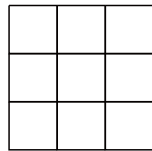

System Layout

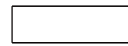

Ceiling Size 300×1200mm

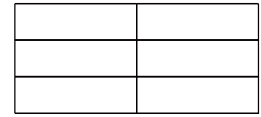

System Layout



Ceiling Size 600×600mm

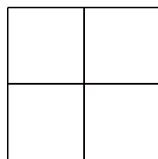

System Layout



Ceiling Size 400×1200mm

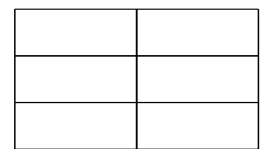

System Layout



Ceiling Size 800×800mm

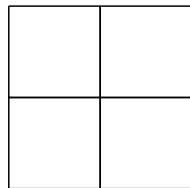

System Layout



Ceiling Size 600×1200mm

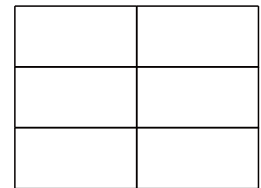

System Layout

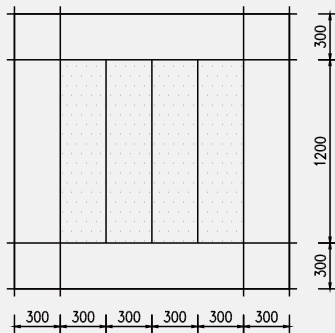

Integrated Suspending System

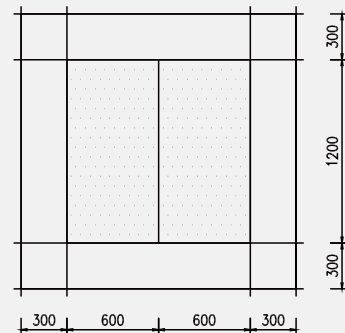

Integrated Suspending System

CLIP IN CEILING

SUSPENSION SYSTEM

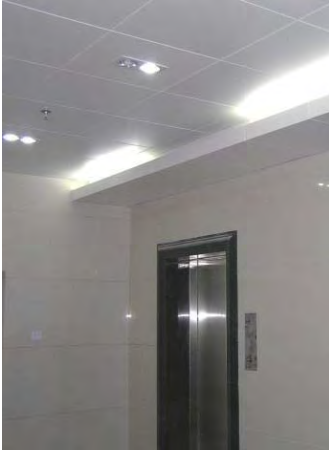

- ① Clip-in Ceiling
- ② H38 Main Runner
- ③ Hanger for Main Runner
- ④ A-shaped Carrier
- ⑤ Hanger for Carrier
- ⑥ Rod Bar

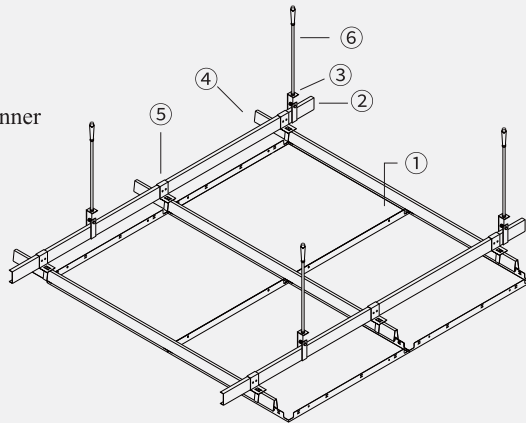

DETAILED DRAWINGS

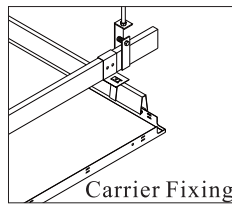
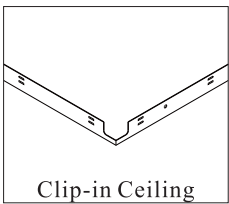

CONSTRUCTION DETAILS

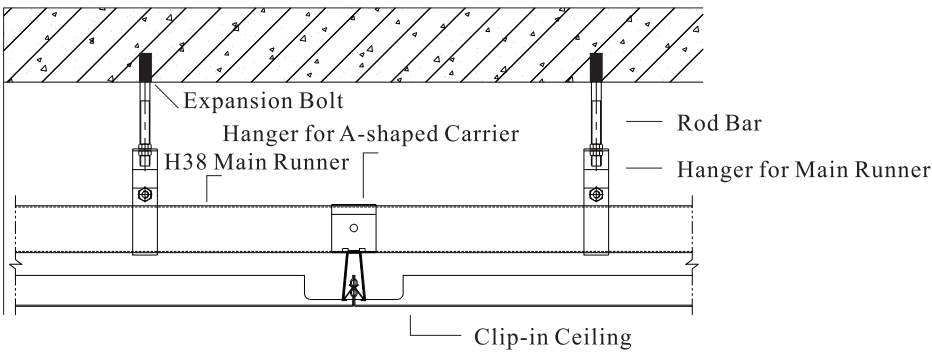

PRODUCT DATA

Material: Aluminum Alloy, Galvanized Steel

Standard Sizes: 300×300mm 600×600mm 800×800mm
300×1200mm 400×1200mm 600×1200mm

Surface Treatment: Powder Coating, PE/PVDF Finish, Anodizing, Heat Transfer Printing.

Normal Perforations:

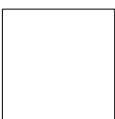

Plain

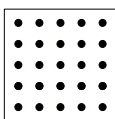

Φ1.0mm Straight

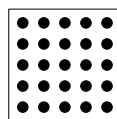

Φ1.5mm Straight

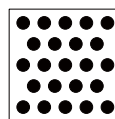

Φ1.8mm Diagonal

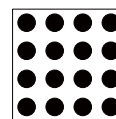

Φ2.5mm Straight

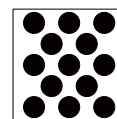

Φ3.0mm Diagonal

CEILING LAYOUT



Ceiling Size 300×300mm

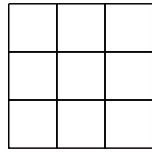

System Layout

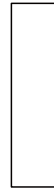

Ceiling Size 300×1200mm

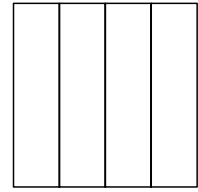

System Layout



Ceiling Size 600×600mm

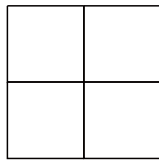

System Layout



Ceiling Size 400×1200mm

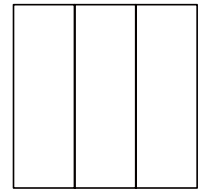

System Layout



Ceiling Size 800×800mm

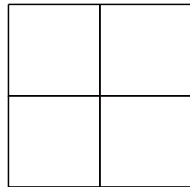

System Layout

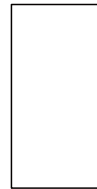

Ceiling Size 600×1200mm

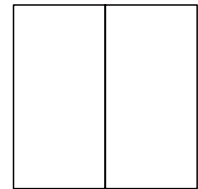

System Layout

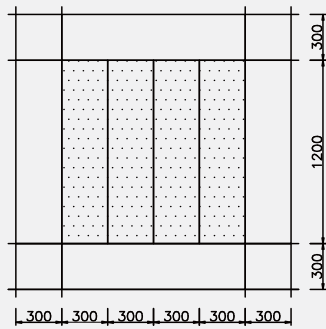

Integrated Suspending System

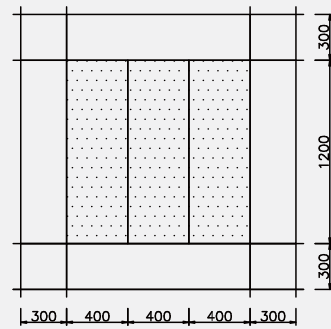

Integrated Suspending System

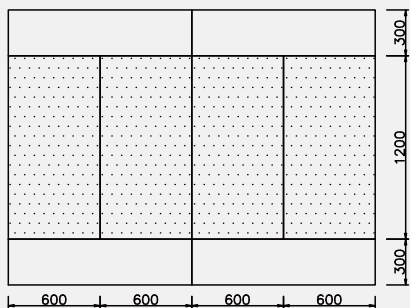

Integrated Suspending System

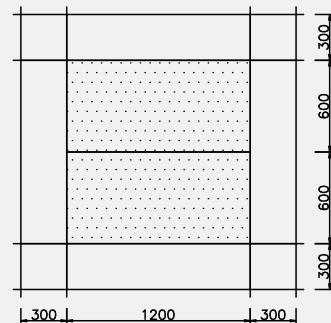

Integrated Suspending System

COLORS

Various colors and shadows as below for choice, and customized colors are available too.
 (Due to printing limitation, color may vary from actual product)

STANDARD COLORS

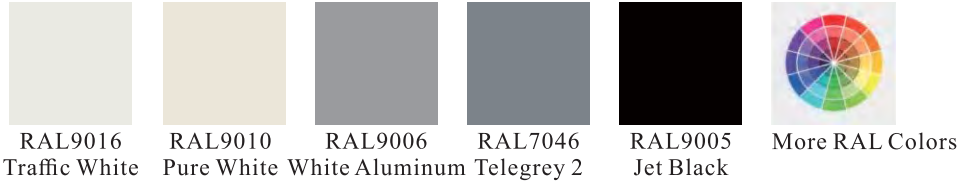

WOOD GRAIN (Interior Film, Heat Transfer, Wood Veneer)



ACCESSORIES

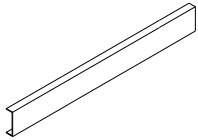

H38 Main Runner
Material:Galvanized Steel
Size:L=3000mm

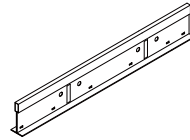

Main Tee
Material:Galvanized Steel
Size:L=3000mm

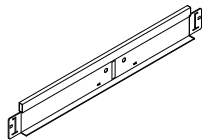

Cross Tee
Material:Galvanized Steel
Size:L=3000mm

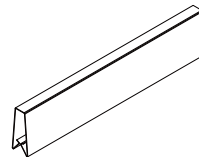

A-shaped Carrier
Material:Galvanized Steel
Size:L=3000mm



Hanger for Main Runner
Material:Galvanized Steel

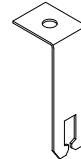

Hanger for Tee Grid
Material:Galvanized Steel

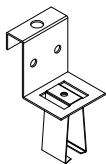

Hanger for Carrier
Material:Galvanized Steel



Expansion Bolt
Material:Galvanized Steel
Size:M8×30mm



Rod Bar
Material:Galvanized Steel
Size:M8×3000mm



Flanged Nut
Material:Galvanized Steel
Size:M8

For different spaces, we have a full set of mature construction system. It's firm & safe, and easy to install. Lightings and air conditioners are recommended to fit ceilings, and to be one part of ceiling systems.



株式会社 シーレックス・ジャパン

〒225-0002

神奈川県横浜市青葉区美しが丘 3-55-2

Tel: 045-909-1515 Fax: 045-909-5012

E-mail: mail@ceillex.co.jp URL: www.ceillex.co.jp

